



KING KING CANADA

23GA. X 2" HEADLESS PIN NAILER



MODEL: 8251PN

INSTRUCTION MANUAL

COPYRIGHT © 2008 ALL RIGHTS RESERVED BY KING CANADA TOOLS INC.

WARRANTY INFORMATION



**2-YEAR
LIMITED WARRANTY
FOR THIS HEADLESS PIN NAILER**

**KING CANADA TOOLS
OFFERS A 2-YEAR LIMITED WARRANTY
FOR NON-COMMERCIAL USE.**

PROOF OF PURCHASE

Please keep your dated proof of purchase for warranty and servicing purposes.

REPLACEMENT PARTS

Replacement parts for this product are available through our authorized King Canada service centers across Canada.

LIMITED TOOL WARRANTY

King Canada makes every effort to ensure that this product meets high quality and durability standards. King Canada warrants to the original retail consumer a 2-year limited warranty as of the date the product was purchased at retail and that each product is free from defects in materials. Warranty does not apply to defects due directly or indirectly to misuse, abuse, normal wear and tear, negligence or accidents, repairs done by an unauthorized service center, alterations and lack of maintenance. King Canada shall in no event be liable for death, injuries to persons or property or for incidental, special or consequential damages arising from the use of our products.

To take advantage of this limited warranty, return the product at your expense together with your dated proof of purchase to an authorized King Canada service center. Contact your retailer or visit our web site at www.kingcanada.com for an updated listing of our authorized service centers. In cooperation with our authorized serviced center, King Canada will either repair or replace the product if any part or parts covered under this warranty which examination proves to be defective in workmanship or material during the warranty period.

PARTS DIAGRAM & PARTS LISTS

Refer to the Parts section of the King Canada web site for the most updated parts diagram and parts list.

KING CANADA INC. DORVAL, QUÉBEC, CANADA H9P 2Y4

www.kingcanada.com



SAFETY INSTRUCTIONS



- Read and understand this manual and all the safety instructions before operating this pin nailer. If you have any questions, please contact our authorized service centres or retailers for help.



- Never allow the use of flammable gases as a power source for the pin nailer. Use filtered, lubricated and regulated compressed air only.



- Never use gasoline or other flammable liquids to clean this pin nailer. Vapors in the pin nailer will ignite by a spark and cause the pin nailer to explode.



- Do not exceed the maximum permissible operating pressure of this pin nailer (120 PSI).

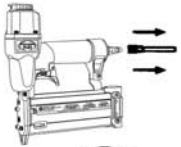

- Disconnect the pin nailer from its air supply before clearing jams, servicing, adjusting and while the pin nailer is not in use.



- Do not keep the trigger pulled when carrying or holding the pin nailer. Never carry the pin nailer by the air hose or pull on the air hose to move the pin nailer.



- At the workplace, always wear protective equipment such as Z87 safety glasses, hearing and head protection.

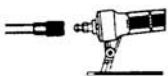

- Do not use a check valve or any other fitting which allows air to remain in the pin nailer.



- Do not place your hand or any part of your body in the pin discharge area of the pin nailer when connecting or disconnecting from the air supply.



- Never point any operational pin driving tool at yourself or at any other person.

GETTING TO KNOW YOUR 23 GA. PIN NAILER

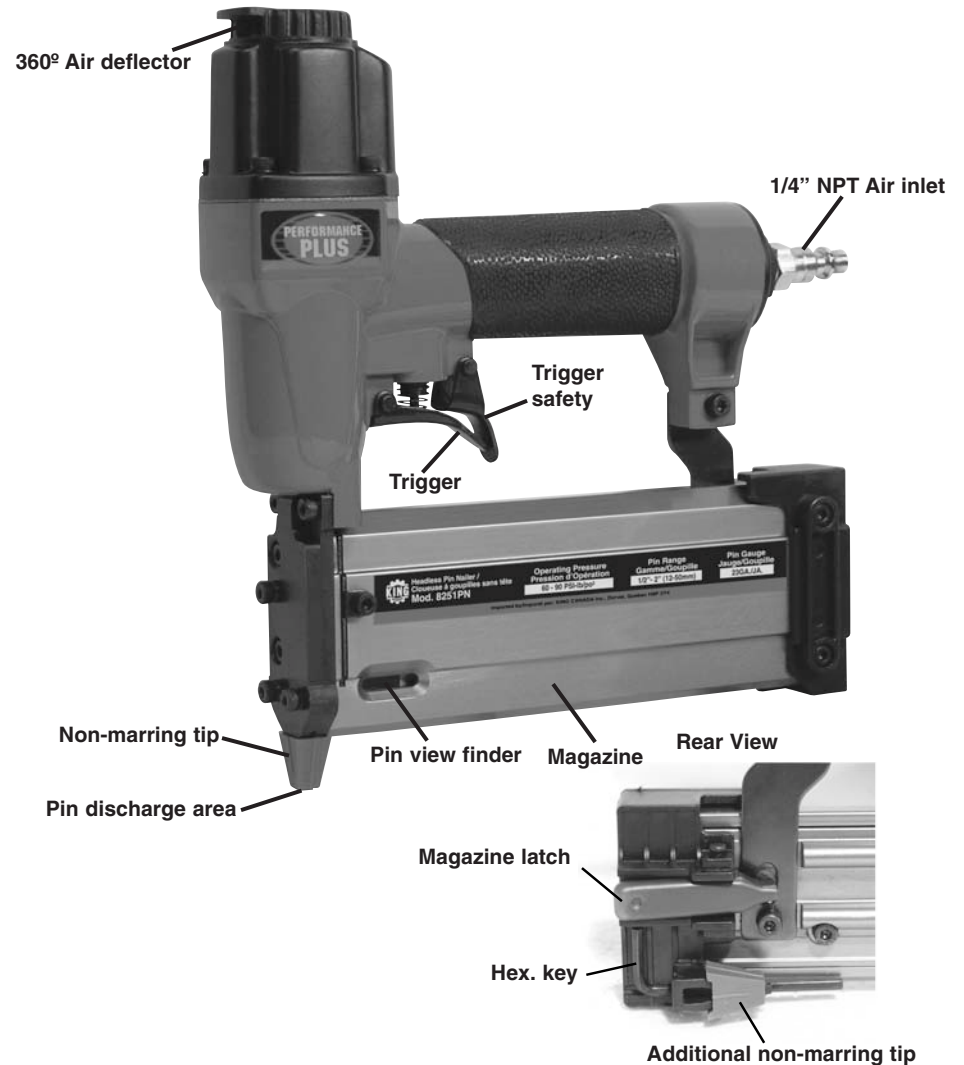

SPECIFICATIONS

Model	8251PN
Air inlet	1/4" NPT
Maximum permissible operating pressure	120 PSIG (8.3 bar)
Recommended operating pressure range	60-90 PSI
Air consumption	3.2 CFM
Pin range	1/2" to 2" (12 - 50mm) 23ga. headless pins
Magazine capacity	120 headless pins



SAFETY TRIGGER & LOADING PINS

SAFETY TRIGGER

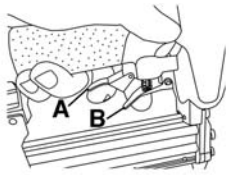

This pin nailer is equipped with a dual safety trigger. A secondary trigger (A) must be depressed first in order to depress the primary trigger (B). Each time the primary trigger is depressed, the pin nailer will fire a single pin.

LOADING MAGAZINE WITH HEADLESS PINS

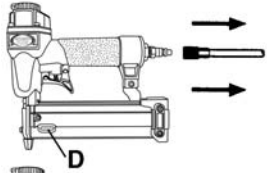

- Disconnect the air hose from the pin nailer air inlet.

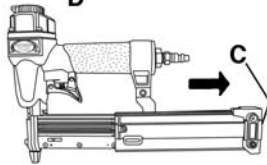

- Depress the magazine latch (C), pull back on the magazine cover.

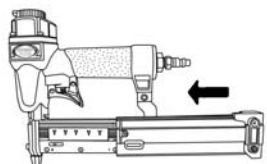

- Insert a stick of headless pins into the magazine with the arrows on the stick pointing downwards. Make sure the ends of the pins are as close to the bottom edge of the magazine as possible.

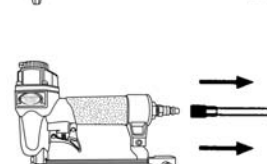

- Push the magazine cover forward until the latch catches.

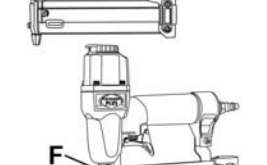

- Observe the pin view finder window (D) during operations to know when the pin supply is low.

CLEARING JAMS

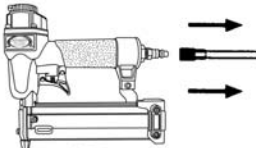

WARNING! Disconnect the pin nailer from the air compressor before adjusting, clearing jams, servicing, relocating and during non-operation.

- Disconnect the air hose from the pin nailer air inlet.

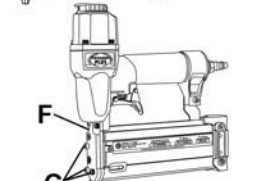

- Depress the magazine latch, pull back on the magazine cover and remove all pins from the magazine.

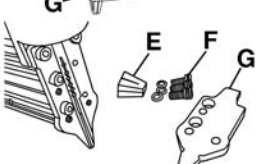

- Remove the non-marring tip (E) by pulling it downwards, remove the front cover (F) by removing 3 cap screws (G).

- Remove jammed pin using pliers, reposition front cover and secure it in place with the same 3 cap screws removed previously. Reposition the non-marring tip.

- Reload pins in magazine and make sure the magazine cover latch catches.



AIR SUPPLY, CONNECTIONS & OPERATING

AIR SUPPLY AND CONNECTIONS

WARNING!

THE FOLLOWING ILLUSTRATION SHOWS THE CORRECT MODE OF CONNECTION TO THE AIR SUPPLY SYSTEM WHICH WILL INCREASE THE EFFICIENCY AND USEFUL LIFE OF THE NAILER.

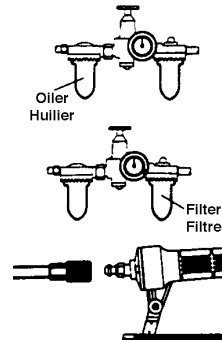
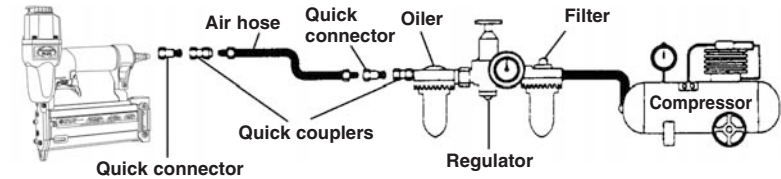

- Many air tool users find it convenient to use an oiler to help provide oil circulation through the tool and it increases the efficiency and useful life of the tool. Check oil level in the oiler daily.

- Many air tool users find it convenient to use a filter to remove moisture and impurities which can rust or wear internal parts of the tool. A filter also increases the efficiency and useful life of the tool. The filter must be checked on a daily basis and, if necessary, drained.

- For better performance, install a 0,95 cm (3/8") quick connector (1/4" NPT threads) with an inside diameter of .315" (0,8 cm) on your tool and a 0,95 cm (3/8") quick coupler on the air hose.

OPERATING YOUR PIN NAILER



WARNING! protect your eyes and ears. Wear Z87 safety glasses with side shields. Wear hearing protection. Employers are responsible for ensuring the user or anyone near the pin nailer wears the above mentioned safety protection.



WARNING! Check and replace any damaged or worn components.

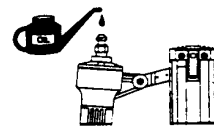

- Add one/two drops of 30W oil for air tools into the air inlet.

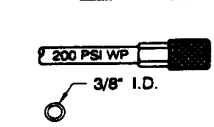

- Install a quick connect fitting to the nailer.



- Connect the pin nailer to an air compressor using a 0,95 cm (3/8") I.D. hose. Make sure the magazine does not contain any pins and that the air hose has a rated working pressure exceeding 200 psi and a female quick coupler.



- Regulate the air pressure to obtain 85 psi.



- Load magazine with pins following the instructions in this manual.

- Reconnect the air hose to the pin nailer air inlet.

- Test for proper pin penetration by driving pins into scrap wood. If the pins do not achieve the desired penetration, regulate the air pressure to a higher setting until the desired penetration is achieved. Do not exceed 100 psi.



MAINTENANCE & TROUBLESHOOTING

LUBRICATION AND MAINTENANCE

- Your pin nailer needs to be lubricated before and after the first time you use it.
- Disconnect the air supply from the pin nailer before lubricating.
- Turn the pin nailer so that the inlet is facing up and put **ONE DROP** of 30W oil or oil without detergent into the air inlet. Never use detergent oil or additives. Operate the pin nailer briefly after adding oil.
- Wipe off excessive oil at the exhaust. Excessive oil will damage O-rings of the pin nailer. If an in-line oiler is used, manual lubrication on a daily basis through the air inlet is not required.

CLEANING YOUR PIN NAILER

- **Never use gasoline or other flammable liquids to clean the nailer. Vapors in the pin nailer will ignite by a spark and cause the tool to explode and result in death or serious personal injury.**
- Disconnect the air supply from the pin nailer.
- Remove tar buildup with #2 kerosene fuel oil or diesel fuel. Do not allow solvent to get into the cylinder or damage may occur. Dry off the tool completely before use.

REPLACEMENT DRIVER, BUMPER & O-RING REPAIR KITS

After prolonged use of your pin nailer, the internal O-rings, Bumper & Driver may need to be replaced caused by wear & tear. To repair, a complete Driver, Bumper & O-ring Replacement Accessory Kit is available for your pin nailer (model: KW-103). Contact your local King Canada distributor for more information.

TROUBLESHOOTING CHART

WARNING: Stop using this tool immediately if any of the following problems occur. Serious personal injury could occur. Any repairs or replacements must be done by a qualified person or an authorized service centre only.

Problem	Cause	Solution
• Air leaking at trigger valve area.	• O-rings in trigger valve are damaged.	• O-rings must be replaced.
• Air leaking between housing and nose.	• Loose screws in housing. • Damaged O-rings. • Bumper damage.	• Screws need to be tightened. • O-rings must be replaced. • Bumper needs to be replaced.
• Air leaking between housing and cap assembly.	• Loose screws. • Damaged seal.	• Screws need to be tightened. • Seal must be replaced.
• Nailer skips a pin.	• Worn bumper. • Dirt in nailer nose. • Dirt or damage prevents pins from moving freely in the magazine. • Inadequate air flow to nailer. • Worn O-ring on piston or lack of lubrication. • Damaged O-rings on trigger valve. • Air leaks. • Cap seal is leaking.	• Bumper needs to be replaced. • Clean nailer. • Magazine must be cleaned. • Fitting hose and air compressor need to be checked. • O-rings must be replaced, lubricate. • O-rings must be replaced. • Screws and fittings need to be tightened. • Seal needs to be replaced.
• Runs too slowly or has loss of power.	• Not sufficiently lubricated. • Broken spring in cap assembly. • Exhaust port in cap is blocked.	• Lubricate. • Spring needs to be replaced. • Damaged internal parts must be replaced.
• Jammed pins.	• Driver guide worn or damaged. • Pins are bent. • Magazine or nose screws are loose. • Damaged driver.	• Replace driver guide. • Replace with undamaged pins. • Screws need to be tightened. • Replace driver.