

WYNDHAM COLLECTION

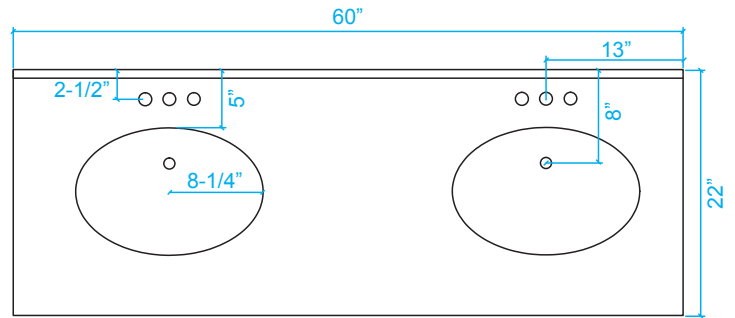

TOP VIEW OF VANITY CABINET

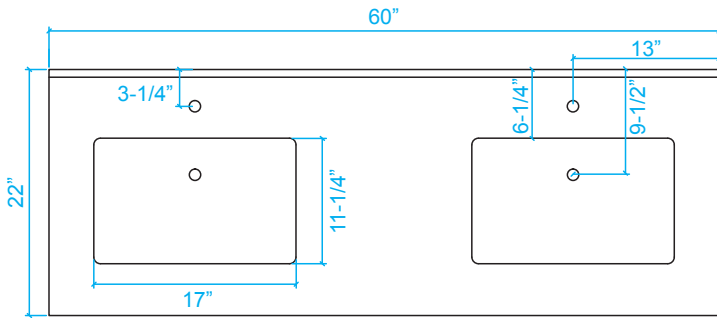
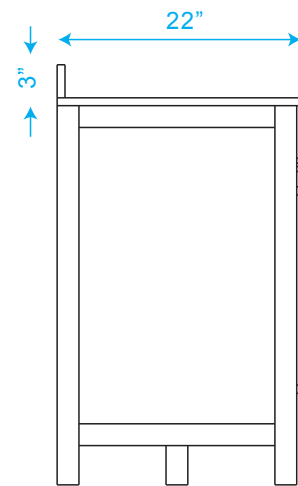
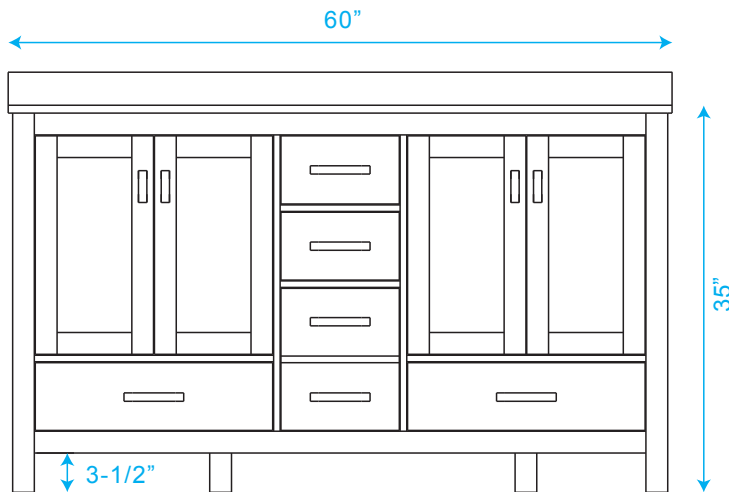
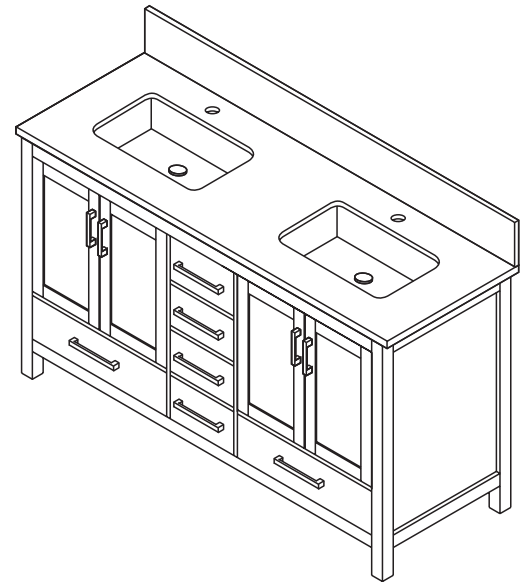
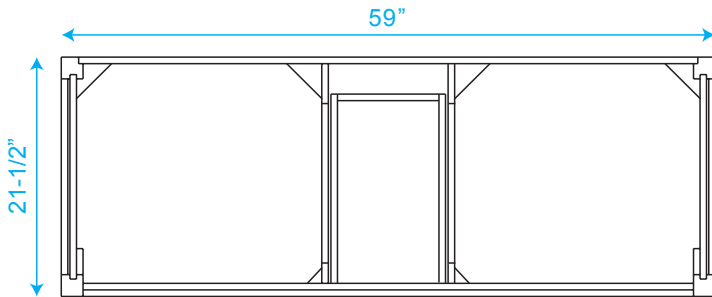

**Note: Due to high probability of breakage, the backsplash comes in two pieces, cut from same piece. All measurements are $\pm 1/4$ "*

WC-1414-60 Double Vanity

WYNDHAM COLLECTION

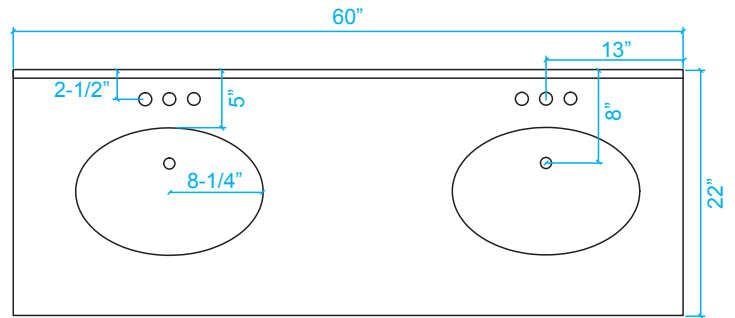
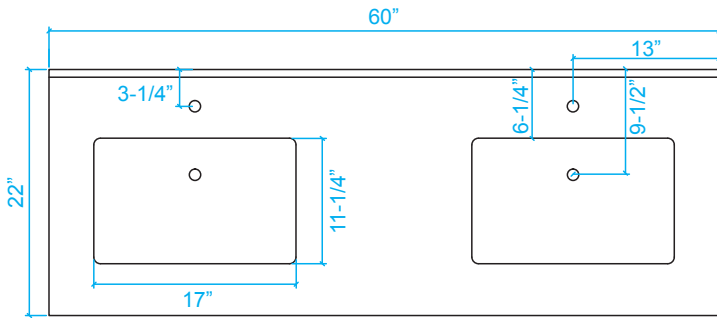

VUE DE DESSUS DU MEUBLE-LAVABO

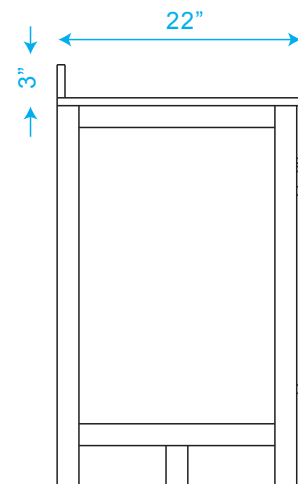
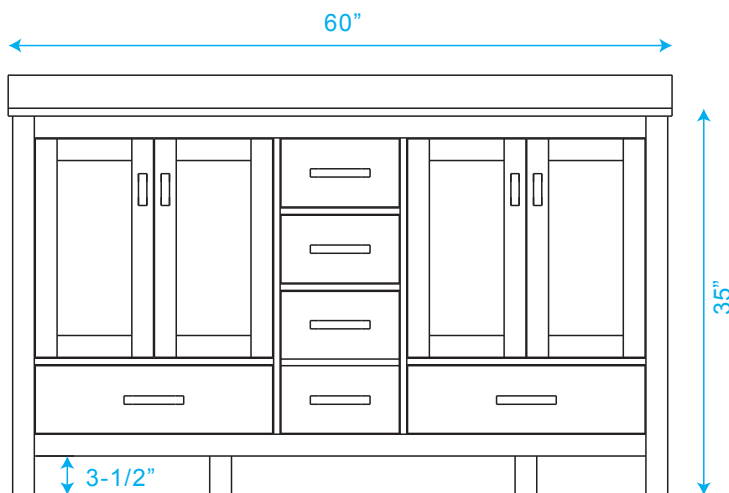
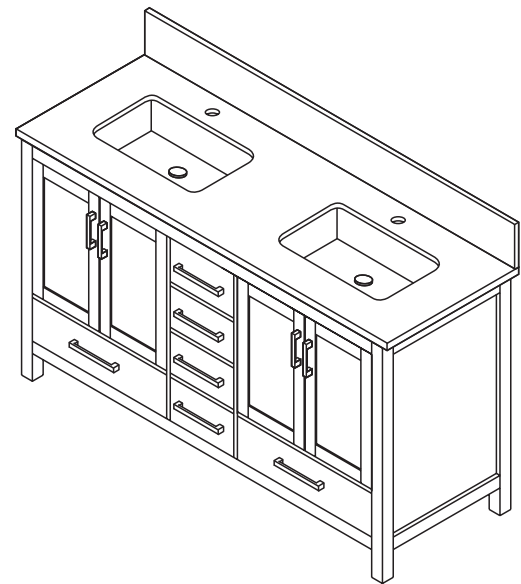
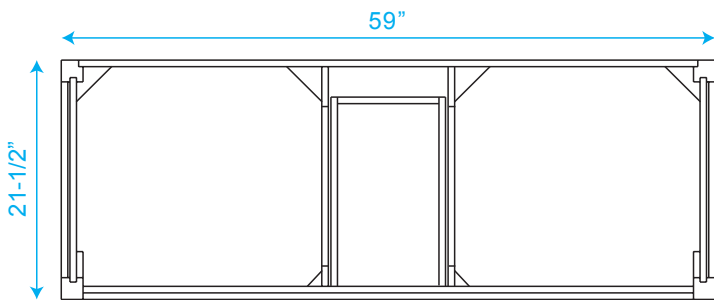

*Remarque: À cause des risques de cassure, le dossier est fourni en deux pièces, coupées à partir de la même pièce. Toutes les mesures sont en $\pm 1/4$ "

WC-1414-60 Double Vanity